

ÇOK FONKSİYONLU ZAMAN RÖLELERİ

MCB-7 MCB-8 MCB-9

MCB-7, MCB-8, MCB-9

Mikroişlemci tabanlı elektronik zaman röleleridir. 0,1 sn.'den 30 saate (MCB-7 için) ya da 999 dakikaya (MCB-8 için), 0,5 sn.'den 30 saate (MCB-9 için) kadar hassas olarak ayarlanabilen zaman skalasına ve dört adede kadar farklı çalışma moduna sahiptirler. Zaman röleleri, ince ve dar boyutlarıyla çok amaçlı kullanıma uygun olarak tasarlanmışlardır.

MCB-7

- ER MODU (Çekmede Gecikmeli)
- EM MODU (Bırakmada Gecikmeli)

MCB-7 kullanıcının isteğine göre ER ya da EM fonksiyonunda çalışan bir zaman rölesidir. 0.1 saniyeden 30 saate kadar ayarlanabilir.

MCB-8

- ER MODU (Çekmede Gecikmeli)
- EM MODU (Bırakmada Gecikmeli)

MCB-8 kullanıcının isteğine göre ER ya da EM fonksiyonunda çalışan bir zaman rölesidir. 0.1 saniyeden 999 dakikaya kadar ayarlanabilir.

MCB-9

- ER MODU (Çekmede Gecikmeli)
- EM MODU (Bırakmada Gecikmeli)
- FLAŞÖR
- AÇIK FLAŞÖR
- KAPALI FLAŞÖR

MCB-9 kullanıcının isteğine göre ER, EM, Kapalı Flaşör ya da Açık Flaşör olarak çalışabilen bir zaman rölesidir. 0.5 saniyeden 30 saate kadar ayarlanabilir.

MCB-7/8/9 EM moduna ayarlandıysa ton, ER moduna ayarlandıysa toff zamanı ayarlanmalıdır.
MCB-9 zaman rölesi açık veya kapalı flaşör ayarlandıysa hem ton hem toff süresi ayarlanmalıdır.

Mod Seçimi (Fonksiyon Tablosu)

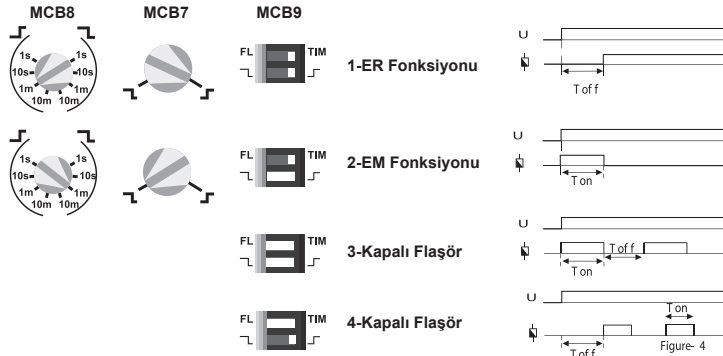

ZAMAN TABLOSU

ZAMAN BÖLGESİ	AYARLANABİLİR ZAMAN ARALIĞI	ZAMAN BÖLGESİ	AYARLANABİLİR ZAMAN ARALIĞI
MCB-7	MCB-7	MCB-9	MCB-9
1 sn.	0.1-1 sn.	5 sn.	0.5-5 sn.
10 sn.	0.1-10 sn.	10 sn.	1-10 sn.
30 sn.	0.1-30 sn.	30 sn.	3-30 sn.
60 sn.	0.1-60 sn.	60 sn.	6-60 sn.
10 dk.	0.1 sn.-10 dk.	10 dk.	1 sn.-10 dk.
60 dk.	0.1 sn.-60 dk.	60 dk.	6 sn.-60 dk.
10 saat	0.1 sn.-10 saat	10 saat	1 saat-10 saat
30 saat	0.1 sn.-30 saat	30 saat	3 saat-30 saat

Sürelerin Ayarlanması

ON ve OFF Süresinin Ayarlanması:

MCB-8: x10 trimpotu istenilen zamanın onlar basamağı, x1 trimpotu birler basamağı ve x0.1 trimpotu ise onda birler basamağını belirler.
Örnek: x10=2, x1=4, x0.1=6, Mode=1s konumunda iken 24.6 saniye sonunda istenilen işlemi yapar

Örnek (MCB-8):



x10	x1	x0.1	Mode	Ayarlanan Zaman
2	4	6	1sn.	24.6 saniye
2	4	6	10sn.	246 saniye
2	4	6	1dk.	24.6 dakika
2	4	6	10dk.	246 dakika

MCB-7/9: On, Off süresi, MCB-7'de zaman bölgesi seçim trimpotunu, MCB-9'da ise 1-2-3 Nolu anahtarları ve toff ya da ton trimpotunu kullanarak aşağıdaki formül uyarınca hesaplanır:

a, seçilen zaman bölgesinin sınırı;
t, istenilen zaman;
x, trimpotun konumu olmak üzere;

$$X = \frac{10.t}{a} \text{ ve } t = \frac{x}{10} . a$$

Örnek (MCB-7, 9):

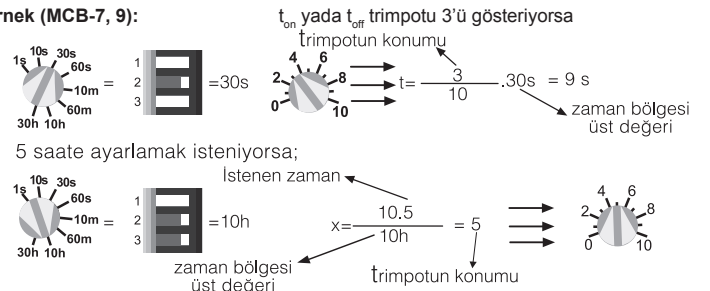

Boyutlar

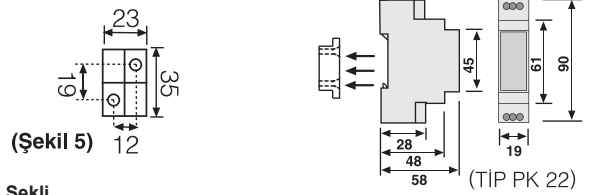

Bağlantı Şekli

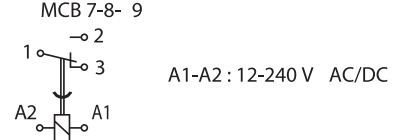

Teknik Bilgi

İşletme Gerilimi (Un)	: 12-240 VAC/DC
İşletme Aralığı	: (0.9-1.1) x Un
İşletme Frekansı	: 50/60 Hz.
Çıkış Kontakı	: 1 Enversör 8A/2000 VA (NO: 8A, NC: 6A)Cosφ = 1
Tekrarlama Hatası	: +/-%0.1
Reset Süresi	: <=150 msn.
Ortam Sıcaklığı	: -5°C ; +50°C
Boyutlar	: Tip PK22
Koruma Sınıfı	: IP 20
Bağlantı Şekli	: Klemensli, klemens rayına montaj, (panoya vida ile montaj adaptör parçası ile mümkündür. Bakınız Şekil 5)

Önemli Uyarı:

1) İşletme gerilimi 1 sn.den kısa bir sürede belirtilen değerlere yükseltilmemelidir.

Doğru Kullanım ve Güvenlik Şartları:

- Aşağıdaki şartlara uyulmaması halinde ölüm ve ciddi yaralanmalar olabilir.
- Cihaz bağlanırken bütün enerjiyi kesiniz.
- Cihaz şebekeye bağlandığında ön paneli çıkartmayınız.
- Cihazı solvent yada benzeri bir madde ile temizlemeye çalışmayınız. Sadece kuru bez kullanınız.
- Bağlantıları kontrol ediniz.
- Elektriksel cihazlar sadece bayiniz tarafından tamir edilmelidir.
- Cihaz sadece pano tipi montaj içindir.
- Kullanılacak sigorta F tipi olmalı ve akım sınırı değeri 1A olmalıdır.



Yukarıdaki önlemlerin uygulanmaması sonucu doğabilecek istenmeyen durumlardan üretici firma hiç bir şekilde sorumlu tutulamaz.

Not: Kontak dayanımı omik yükte (ör: Akkor flemanlı ampul, Rezistanslı cihazlar) 8A'dir. Endüktif (ör = AC motor, florasın(Sargılı balastlı), vb..) ya da Kapasitif (ör = Led Sürücüler, UPS, florasın(Elektronik Balastlı), vb..) yük anahtarlanacaksa kontaktör kullanılması tavsiye edilir. Aksi takdirde cihazın röle kontaklarında yapışma meydana gelebilir.

"Bu ürün, 30.05.2008 tarih ve 26891 sayılı resmî gazetedeki yayımlanan EEE Yönetmeliğinin Madde 2 ve Ek-1A madde 9 kapsamındadır."

MULTIFUNCTIONAL TIME RELAYS

MCB-7 MCB-8 MCB-9

MCB-7, MCB-8, MCB-9

are microprocessor-based electronic time relays. They have precisely adjustable time ranges (between 0,1 s-30 hours for MCB-7; 0,1 s-999 minutes for MCB-8; 0,5 s-30 hours for MCB-9) and up to 4 different operating modes. With their thin and narrow designs, these time relays are designed for multi-purpose applications.

MCB-7

- ER MODE (ON Delay)
- EM MODE (OFF Delay)

MCB-7 is a time relay that works as ER Mode or EM Mode according to the users needs. It can be adjusted between 0,1 seconds and 30 hours.

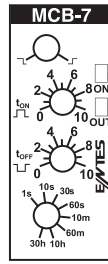

MCB-8

- ER MODE (ON Delay)
- EM MODE (OFF Delay)

MCB-8 is a time relay that works as ER Mode or EM Mode according to the users needs. It can be adjusted between 0,1 seconds and 999 minutes.

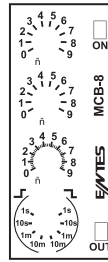

MCB-9

- ER MODE (ON Delay)
- EM MODE (OFF Delay)
- FLASHER
- ON FLASHER
- OFF FLASHER

MCB-9 is a time relay that works as ER Mode, EM Mode, ON Flasher or OFF Flasher according to the users needs. It can be adjusted between 0,5 seconds and 30 hours.

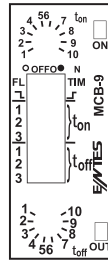

When MCB-7/8/9 are set to EM mode, ton time should be adjusted. When they are set to ER mode, toff time should be adjusted. When MCB-9 is set to ON or OFF flasher, both ton and toff time should be adjusted.

Mode Selection (Function Table)

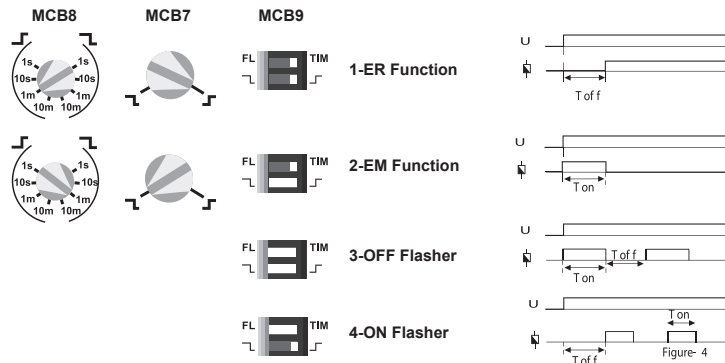

TIME TABLE

TIME INTERVAL	ADJUSTABLE TIME RANGE	3	2	1	TIME INTERVAL	ADJUSTABLE TIME RANGE
MCB-7	MCB-7				MCB-9	MCB-9
1 sec	0.1-1 sec	○	○	○	5 sec	0.5-5 sec
10 sec	0.1-10 sec	○	○	●	10 sec	1-10 sec
30 sec	0.1-30 sec	○	●	○	30 sec	3-30 sec
60 sec	0.1-60 sec	○	●	●	60 sec	6-60 sec
10 min	0.1 sec-10 min	●	○	○	10 min	1 min-10 min
60 min	0.1 sec-60 min	●	○	●	60 min	6 min-60 min
10 hours	0.1 sec-10 h	●	●	○	10 hours	1 hours-10 hours
30 hours	0.1 sec-30 h	●	●	●	30 hours	3 hours-30 hours

Adjusting The Times

Adjusting the ON and OFF Times

MCB-8: x10 trimpot is used to adjust the ones digit of the desired time, x1 trimpot is used to adjust the tens digit of the desired time and x0.1 trimpot is used to adjust the tenths digit of the desired time.

Example: When the trimpots are adjusted as x10=2, x1=3, x0.1=6, Mode=1s; the relay does the desired function after a 24.6 seconds delay.

Example (MCB-8):



x10	x1	x0.1	Mode	Adjusted Time
2	4	6	1s	24.6 seconds
2	4	6	10s	246 seconds
2	4	6	1m	24.6 minutes
2	4	6	10m	246 minutes

MCB-7/9: The ON-OFF time is adjusted according to the following formula by using the time range selection trimpot on MCB-7 and by using the switches numbered as 1-2-3 and toff or ton trimpots on MCB-9:

a, limit of the selected time range;

t, desired time;

x, trimpot position;

$$x = \frac{10 \cdot t}{a} \text{ and } t = \frac{x}{10} \cdot a$$

Example (MCB-7,9):

If t_{on} or t_{off} trimpot is at position 3

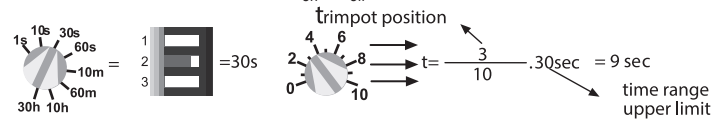

To set it to 5 hours;

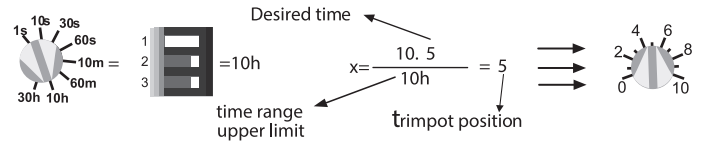

Dimensions

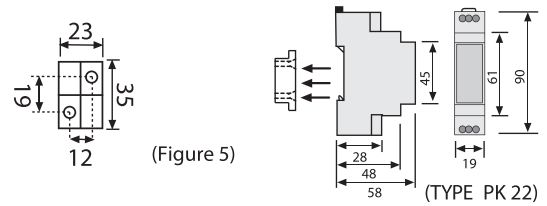

Connection Diagram

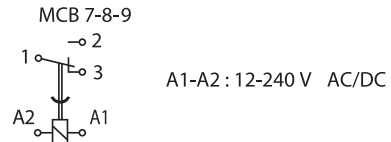

Technical Data

Rated Voltage (Un)	:12-240 VAC/DC
Operating Range	: (0.9-1.1) x Un
Operating Frequency	: 50/60 Hz.
Output Contact	: 1 Changeover 8A/2000 VA (NO: 8A, NC: 6A)Cosφ = 1
Repetition Error	: +/-0.1%
Reset Time	: <=150 msec.
Ambient Temperature	: -5°C ; +50°C
Dimensions	: Type PK22
Protection Class	: IP 20
Connection	: Terminal connection, Rail-mount (Panel mount is available with the plastic adapter part. Refer to fig. 5)

Caution:

1) Operating voltage must raise to the indicated value in less than 1sec.

PRECAUTIONS FOR INSTALLATION AND SAFE USE

- Failure to follow those instructions will result in death or serious injury.
- Disconnect all power before installing the equipment.
- When the device is connected to the network, do not remove the front panel.
- Do not try to clean the device with solvent or the like. Only clean with dry cloth.
- Verify correct terminal connections when wiring.
- Electrical equipment should be serviced only by your component seller.
- Device is for panel mount only.
- An F type fuse with 1 ampere limit current value must be used.

No responsibility is assured by the manufacturer or any of its subsidiaries for any consequences arising out of the use of this material.

Note: The contact resistance at ohmic load (eg: Incandescent bulb, Resistance devices) is 8A. It is recommended to use a contactor if the inductive load (eg: AC motor, fluorescent, etc.) or capacitive load (eg: Led Drivers, UPS, Fluorescent (Electronic Ballast), etc.) switch. Otherwise adhesion may occur in relay contacts.

MULTIFUNKTIONALE ZEITRELAIS

MCB-7 MCB-8 MCB-9

MCB-7, MCB-8, MCB-9

Multifunktionale, Mikroprozessor-basierte Zeitrelais. Diese Geräte sind tauglich zur multifunktionalen Verwendung und wurden mit einer von Sekunden bis Stunden exakt einstellbaren Zeitschaltuhr, verschiedene Programmiermethoden und einem kleinen Gehäuse entwickelt.

MCB-7

- ER-MODUS (Einschaltverzögerung)
- EM-MODUS (Ausschaltverzögerung)

MCB-7 ist ein Zeitrelais, welches auf Wunsch des Benutzers im ER und EM-Modus funktioniert. Das Gerät kann von 0.1 Sekunden bis 30 Stunden eingestellt werden.

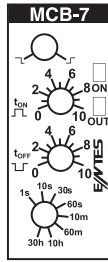

MCB-8

- ER-MODUS (Einschaltverzögerung)
- EM-MODUS (Ausschaltverzögerung)

MCB-8 ein Zeitrelais, welches auf Wunsch des Benutzers im ER und EM-Modus funktioniert. Das Gerät kann von 0.1 Sekunden bis 999 Minuten eingestellt werden.

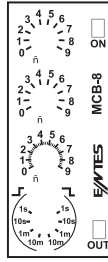

MCB-9

- ER-MODUS (Einschaltverzögerung)
- EM-MODUS (Ausschaltverzögerung)
- BLINKER
- BLINKER ON
- BLINKER OFF

MCB-9 ist ein Zeitrelais, das auf Wahl des Benutzers im ER/EM-Modus, mit oder ohne Blinker funktioniert. Das Gerät kann von 0.5 Sekunden bis 30 Stunden eingestellt werden.

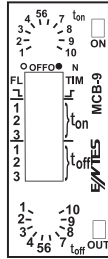

Einstellung der Zeitspannen

Einstellung der ON und OFF-Dauer

MCB-8: X10 trimpod wird verwendet, um die Zehnerstelle des Koeffizienten einzustellen, x1 trimpod wird verwendet, um die Ziffer des Koeffizienten einzustellen, und x0,1 trimpod wird verwendet, um die zehnte Ziffer des Koeffizienten einzustellen. Modus (unten) trimpod wird verwendet, um den Moduswert einzustellen, der mit dem Koeffizienten multipliziert wird, um die gewünschte Zeit zu erhalten.

Beispiel: Wenn die Trimponds als x10 = 2, x1 = 4, x0,1 = 6, Modus = 1s eingestellt sind, führt das Relais nach einer Verzögerung von 24,6 Sekunden die gewünschte Funktion aus.

Beispiel (MCB-8):



x10	x1	x0.1	Mode	Ayarlanan Zaman
2	4	6	1Sek.	24.6 Sek.
2	4	6	10Sek.	246 Sek.
2	4	6	1Min.	24.6 Min.
2	4	6	10Min.	246 Min.

MCB-7/9: Die Ein-Aus-Dauer wird gemäß der folgenden Formel

*unter Verwendung der Zeitbereichswahl-Trimpod (für MCB-7)

*unter Verwendung der DIP-Schalter, die als 1-2-3 numeriert sind, und t-ON oder t-ON-Trimponds (für MCB-9) eingestellt. $X = \frac{10 \cdot t}{a}$ und $t = \frac{x}{10} \cdot a$

a, Grenzwert von der gewählte Zeitspanne (Modus)

t, Gewünschte Zeit

x, Trimpodstelle

Beispiel (MCB-7, 9):

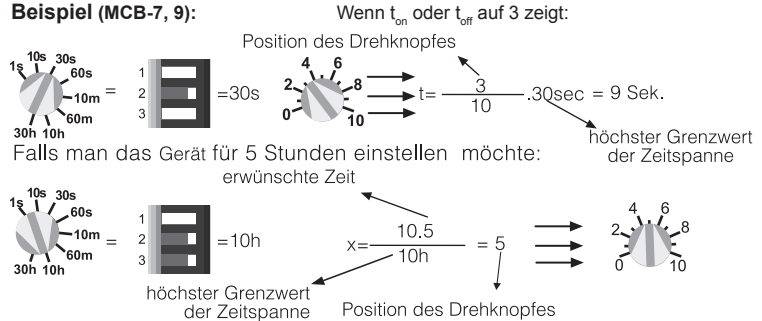

Wenn der MCB-7/8/9 in den EM-Modus geschaltet ist, sollte die Zeit ton angepasst werden. Wenn sie auf den ER-Modus eingestellt sind, sollte die Zeit toff angepasst werden.

Wenn der MCB-9 auf EIN oder AUS gestellt ist, sollten sowohl die Zeit ton als auch die Zeit toff eingestellt werden.

Wahl der Betriebsart (Funktionstabelle)

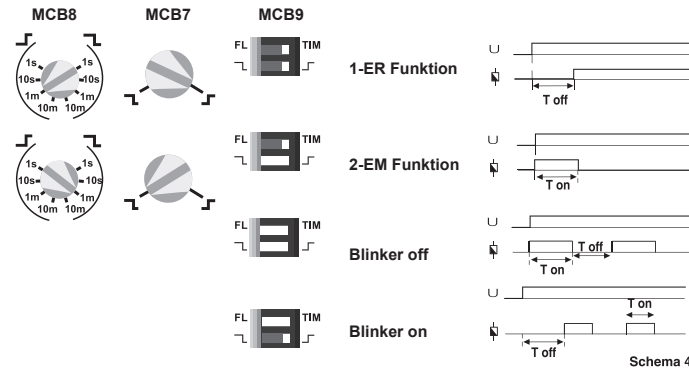

ZEITABELLE

Zeitintervall	Einstellbare Periode	3	2	1	Zeitintervall	Einstellbare Periode
MCB-7	MCB-7				MCB-9	MCB-9
1 Sek	0.1-1 Sek.	○	○	○	5 Sek	0.5-5 Sek
10 Sek	0.1-10 Sek.	○	○	●	10 Sek.	1-10 Sek.
30 Sek	0.1-30 Sek.	○	●	○	30 Sek.	3-30 Sek.
60 Sek	0.1-60 Sek.	○	●	●	60 Sek.	6-60 Sek.
10 Min.	0.1 Sek.-10 Min.	●	○	○	10 Min.	1 sn.-10 Min.
60 Min.	0.1 Sek.-60 Min.	●	○	●	60 Min.	6 sn.-60 Min.
10 Std.	0.1 Sek.-10 Std.	●	●	○	10 Std.	1 Std.-10 Std.
30 Std.	0.1 Sek.-30 Std.	●	●	●	30 Std.	3 Std.-30 Std.

Abmessungen

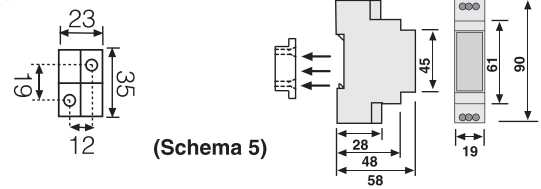

Anschluss

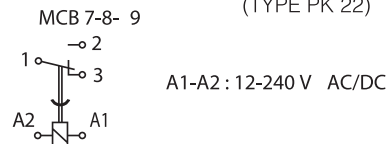

Technische Daten

Betriebsspannung (Un)	: 12-240VAC/DC
Betriebsbereich	: (0.9-1.1) x Un
Betriebsfrequenz	: 50/60 Hz.
Ausgangskontakte	: 1 Wechslerlichter 8A/2000 VA (NO: 8A, NC: 6A)Cosφ = 1
Wiederholungsfehler	: +/- %0.1
Nachstellzeit	: <= 150 ms.
Umgebungstemperatur	: -5°C ; +50°C
Abmessungen	: Typ PK22
Schutzklasse	: IP 20
Anlage	: auf DIN Hutschiene (Schalttafelmontage mgl. mit passendem Adapter, siehe Schema 5)

Vorsicht:

1) Die Nennspannung muss innerhalb einer Sekunde auf den definierten Wert erhöht werden.

Vorsichtsmassnahmen zur Installation und sicheren Verwendung:

- Die Nichtverfolgung dieser Anweisungen kann zu schweren Verletzungen bis hin zum Tod führen.
- Vor Inbetriebnahme bitte alle Arten von Energie vom Gerät trennen.
- Die Frontplatte nach Netzanschluss nicht entfernen.
- Das Gerät nicht mit einem Lösungsmittel oder seinesgleichen reinigen. Zur Reinigung bitte nur ein trockenes Tuch verwenden.
- Vor Inbetriebnahme bitte alle Terminalverbindungen überprüfen.
- Elektrische Geräte sollten nur von Ihrem Komponentenverkäufer gewartet werden.
- Die elektrische Sicherung soll als F-typ und Sicherungsgrenzwert von 1A benutzt werden.



Der Hersteller übernimmt keine Haftung für Folgen, die sich aus Nichteinhaltung oben genannter Anweisungen entstehen.

Hinweis: Der Kontaktwiderstand bei ohmscher Last (z. B. Glühlampe, Widerstände) beträgt 8 A. Sie sollten einen Schütz verwenden, wenn die induktive Last (z. B. Wechselstrommotor, Leuchtstofflampe usw.) oder kapazitive Last (z. B. LED-Treiber, USV, Leuchtstofflampe (elektronisches Vorschalgerät) usw.) wechselt. Andernfalls kann eine Adhäsion in Relaiskontakten auftreten.

ENTES Elektronik Cihazlar Imalat ve Ticaret A.S.

Adr: Dudullu OSB; 1. Cadde; No:23 34776
Ümraniye - İSTANBUL / TÜRKİYE

Tel: +90 216 313 01 10 **Fax:** +90 216 314 16 15

E-mail: iletisim@entes.com.tr - contact@entes.eu

Web: www.entes.com.tr - www.entes.eu

Technical Support Call Center: +90 850 888 84 25



A5312/Rev.9